

# circuit breaker, switches & accessories

## Circuit Breaker Accessories

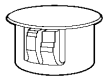

Accessory	Description	Qty/ Pkg	Item Number
Panel Plugs 5/8" (Black) 15.9 mm	Used in Electrical Control Panels	2	553020



Line-to-Line Jumper	Used in Terminal Blocks w/ 5/8" /15.9 mm between holes (100 Amps Total Capacity)	5	553021
---------------------	--	---	--------

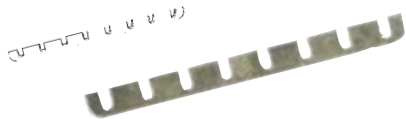

Circuit Breaker Bus Bar	Gangs up to 8 Single Pole Breakers w/ 3/4" /19 mm between notches	1	553022
----------------------------	--	---	--------



Mounting Screws Black	Nylon (6 - 32 x 5/16") /4x7.9 mm Used in mounting Circuit Breakers to Electrical Control Panels	12	553041
--------------------------	---	----	--------

## Electrical Control Panels

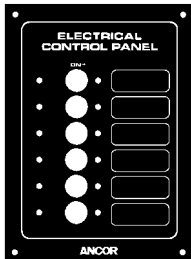

1/8" Thickness

Control Panels for:	Gang	Width (in)	Height (in)	Panel Color	Qty/ Pkg	Item Number
Standard Toggle Breakers	2	2 - 11/16"	4 - 1/4"	Black	1	553002
		6.8 cm	10.8 cm			
	4	5 - 3/8"	4 - 1/4"	Black	1	553004
		13.7 cm	10.8 cm			
	6	5 - 3/8"	7 - 3/8"	Black	1	553005
		13.7 cm	18.7 cm			
	8	5 - 3/8"	8 - 1/2"	Black	1	553008
		13.7 cm	21.2 cm			
Large Toggle Breakers	2	2 - 11/16"	4 - 1/4"	Black	1	553402
		6.8 cm	10.8 cm			

## Switch Wiring Diagrams

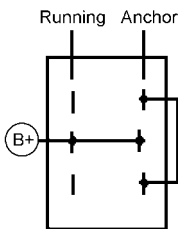

Anchor / Running Lights  
DPDT  
ON-OFF-ON

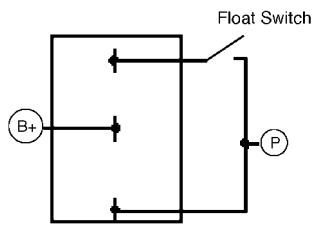

Bilge Pump  
SPDT  
ON-OFF-(ON)

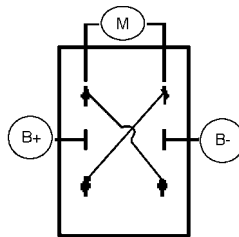

Reversing  
DPDT

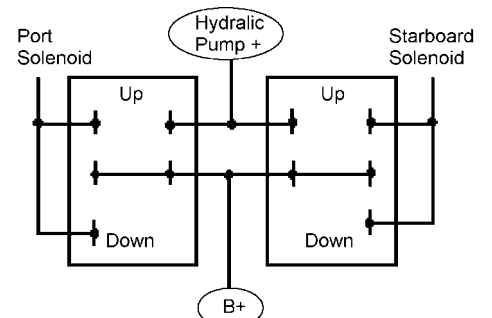

Trimtabs  
Note: 2 DPDT  
(ON)-OFF-(ON)

- = Connection
- () = Momentary
- B = Battery
- B+ = Positive Battery Terminal
- B- = Negative Battery Terminal